

INFO

3/2019

www.alcaplast.com

PREMIUM QUALITY
AT LOWER PRICE



NEWS

WC flexi connectors PREMIUM

Double connectors P155Z, P156Z

Easy clean waste outlets A392C,
A504CKM, A507CKM

CONTENT

WC FLEXI CONNECTORS PREMIUM 3



DOUBLE CONNECTORS P155Z, P156Z 5



EASY CLEAN WASTE OUTLETS A392C, A504CKM, A507CKM 9



PLASTIC SHOWER DRAINS WITHOUT ODOUR TRAP APZ2012C AND APZ2022C 12



INDEX..... 14

ISH

Alca PLAST®

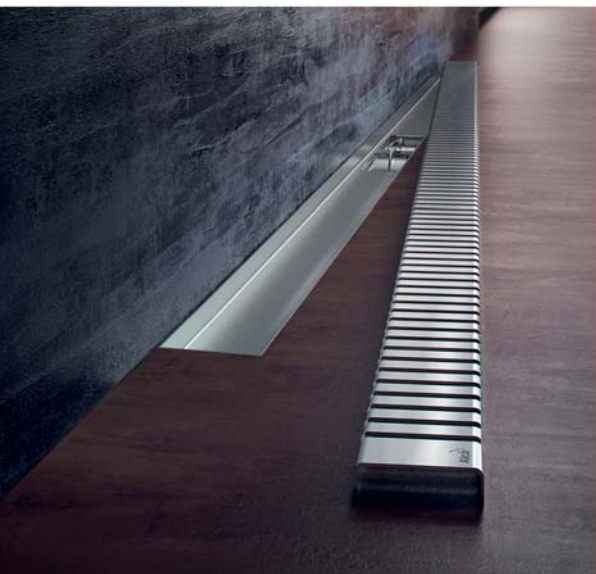

INVITATION

We are pleased to invite you to the world's leading trade fair, **ISH Frankfurt The Bathroom Experience**, which will be held **from 11 to 15 March 2019**.

You will find us in **pavilion 4.0 in stand B85**. We look forward to seeing you.

The Alcaplast team.

www.alcaplast.com

NEW

3

WC flexi connectors – extension of product line PREMIUM

We are extending the product line **PREMIUM – WC flexi connectors A97SN and A97L**.

- Higher quality product at a lower price
- Made in Czech Republic
- 3 innovations for simple installation and extended service life



EXTENDED SERVICE LIFE

PERMANENT STRENGTH AND 100% TIGHTNESS OF THE JOINT

Modern technology – spin welding



ACCURATE AND QUICK INSTALLATION

SEAL AS INTEGRAL PART OF CONNECTOR

Two-component joint for maximum tightness, resistance and durability

Lower price

NEW



QUALITY MATERIAL PROCESSING AND HIGH DURABILITY

NEW TWICE AS THICKER MATERIAL OF THE WALL

- No need of wire reinforcement
- Made of polypropylene thermally and chemically resistant



CZECH PRODUCT

NEW

4

WC flexi connectors – extension of product line PREMIUM

- Higher quality product at a lower price
- Made in Czech Republic
- 3 innovations for simple installation and extended service life

A97SN

WC flexi connector

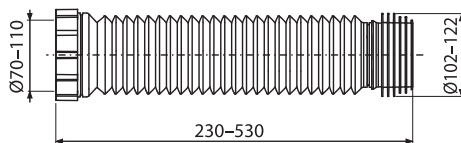

A97L

WC flexi connector

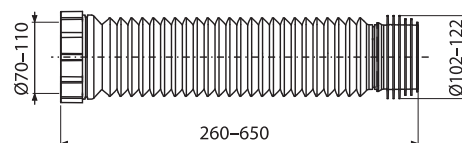

FROM
4/2019

Quantity (packing) A97SN	20 pcs
Dimensions (piece)	200×120×120 mm
Weight (piece)	0.4156 kg
EAN	8595580562366

Quantity (packing) A97L	20 pcs
Dimensions (piece)	260×122×122 mm
Weight (piece)	0.38 kg
EAN	8595580562755

WC flexi connectors – PREMIUM line

N



A97SN

Replaces WC flexi connector



A97S

N



A97L

NEW

5

Double connectors P155Z and P156Z to connect household appliances to trap

You will appreciate them not only in small apartments, but also in the technical rooms or when installing another household appliance. Double connector elegantly solves the problem of connecting two different household appliances to a single trap. Thanks to the variable diameters of the connectors it is possible to connect it to almost all types of common household appliances such as washing machine, dishwasher, dryer, condensing boiler, air conditioning, heat recovery, etc.



P155Z

Double connector 17–23 with return valves



P156Z

Double connector 8–23 with return valves

NEW

6

Double connectors P155Z and P156Z

■ Solution for all situations – direct connection to HT DN40/DN32

EFFECTIVE PROTECTION
Return valve prevents the backflow of water, this solution is suitable for systems that lack their own return valves

SOLUTION FOR ALL SITUATIONS
 Direct connection to **HT DN40/DN32** – no need of another trap when installing additional household appliance

WIDE VARIABILITY
CONNECTOR FOR A HOSE DIAMETER 8–16 MM
 Dryers, boilers, air conditioning, heat recovery etc.

WIDE VARIABILITY
CONNECTOR FOR A HOSE DIAMETER 17–23 MM
 Washing machines, dishwashers etc.

A SAFE BET
The barrier regulates the water flow and eliminates the risk of back flow into the second connector

READY FOR THE FUTURE
End cap serves to blind the connector when not in use – preparation for connecting another household appliance in the future

NEW

7

P155Z

Double connector 17–23 with return valves

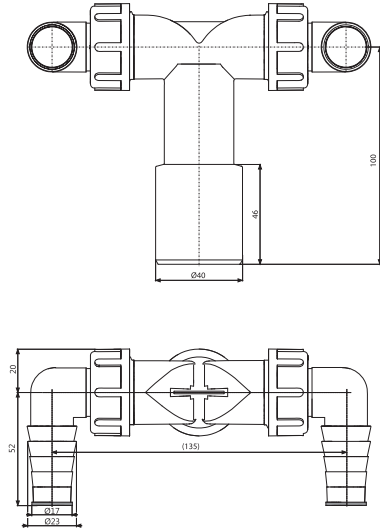

Quantity (packing) P155Z	50 pcs
Dimensions (piece)	125x72x94 mm
Weight (piece)	0.1202 kg
EAN	8595580562502

P156Z

Double connector 8–23 with return valves

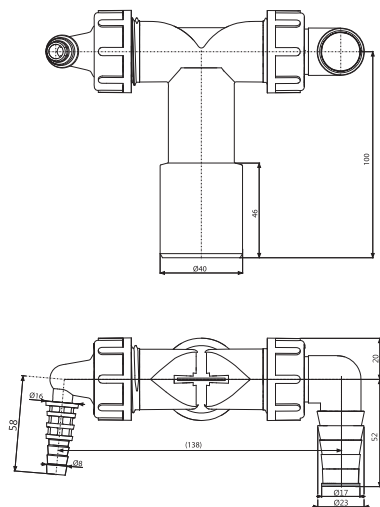

Quantity (packing) P156Z	50 pcs
Dimensions (piece)	125x72x94 mm
Weight (piece)	0.1105 kg
EAN	8595580562519

Double connectors for connecting household appliances to the trap

N



P155Z

Double connector 17-23 with return valves

N



P156Z

Double connector 8-23 with return valves



P148

Double connector G1"/17-23



P148Z

Double connector G1"/17-23 with return valves



P149Z

Double connector G1"/8-23 with return valves



P0048-ND

Connector set G1"/17-23



P0049-ND

Double connector G1"/17-23 with return valves

NEW

9

Easy clean waste outlets A392C, A504CKM, A507CKM

For the selected washbasin and bath waste and traps we offer now the innovated solution with a **removable waste outlet** that could be comfortably **cleaned from above**. Routine maintenance of the trap is faster and more comfortable.



NEW

10

A392C

Wash-basin CLICK/CLACK waste 5/4", metal with overflow, big plug

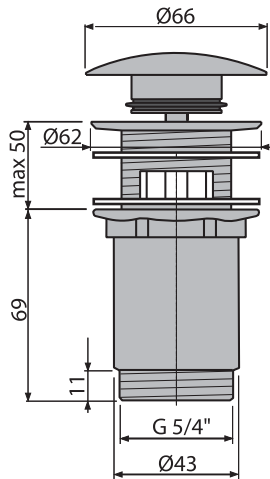

REMOVABLE
WASTE OUTLET



Quantity (packing) A392C	30 pcs
Dimensions (piece)	150x75x75 mm
Weight (piece)	0.3579 kg
EAN	8595580561543

A504CKM

Bath CLICK/CLACK waste and trap, metal

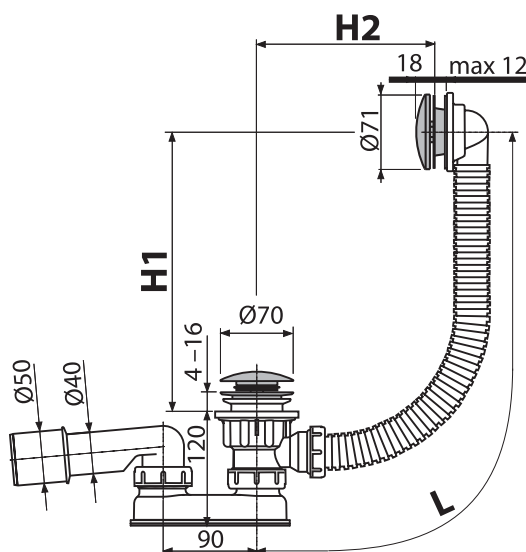

REMOVABLE
WASTE OUTLET



Quantity (packing) A504CKM	20 pcs
Dimensions (piece)	330x120x220 mm
Weight (piece)	0.7375 kg
EAN	8595580562540

NEW

11

A507CKM

Bath CLICK/CLACK waste and trap, metal

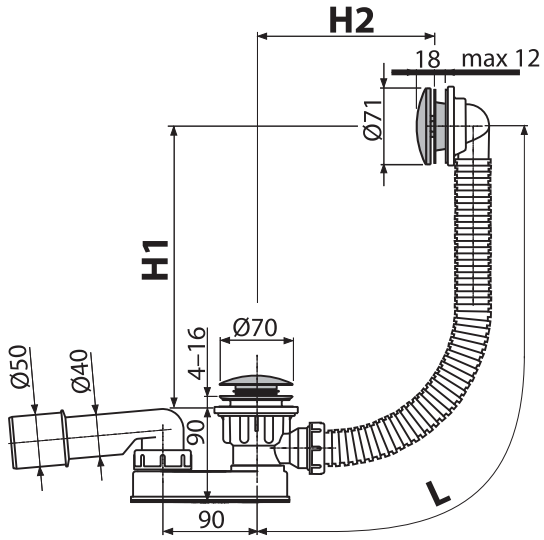

Quantity (packing) A507CKM	20 pcs
Dimensions (piece)	370×200×100 mm
Weight (piece)	0.7222 kg
EAN	8595580562533

NEW

12

Plastic shower drains without odour trap APZ2012C and APZ2022C

Plastic shower drains without odour traps are now available also with coupling nut that enables the easy connection to the waste pipe.



COUPLING NUT G2"

Characteristics of plastic shower drains (type APZ12)

	Plastic edge	Stainless steel edge	No trap	Coupling nut
APZ12	■			
APZ2012	■		■	
APZ2012C	■		■	■
APZ22		■		
APZ2022		■	■	
APZ2022C		■	■	■

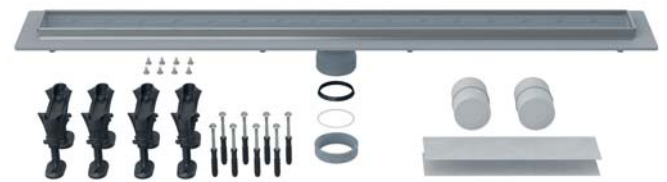
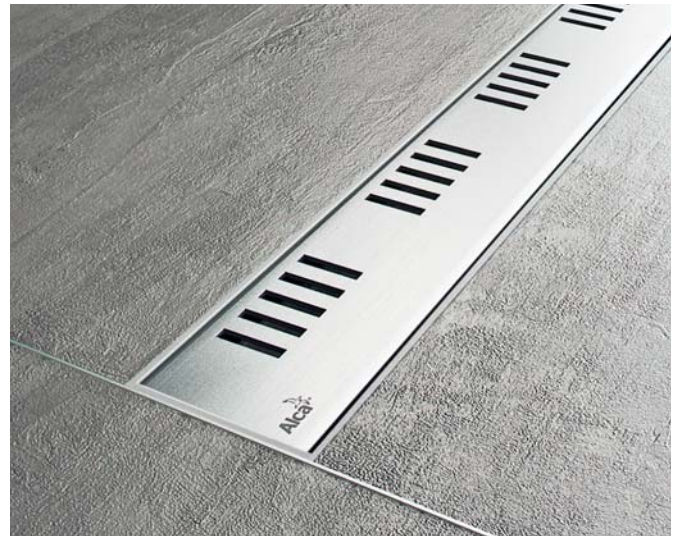

Package content

- Linear shower drain
- Waterproof tape at the length of the linear drain
- Anchoring kit (screws, dowels)
- Installation legs

Grids for linear shower drains APZ2012C and APZ2022C

LINE Stainless steel-polished / Stainless steel-matt



BUBLE Stainless steel-polished / Stainless steel-matt



PURE Stainless steel-polished / Stainless steel-matt



HOPE Stainless steel-polished / Stainless steel-matt



CUBE Stainless steel-polished / Stainless steel-matt



SOLID Stainless steel-matt



DREAM Stainless steel-polished / Stainless steel-matt



TILE Grid for embedding tiles



NEW

13

APZ2012C

Shower drain with an edge for perforated grids or tile embedding, without odour trap
(550, 650, 750, 850 mm)

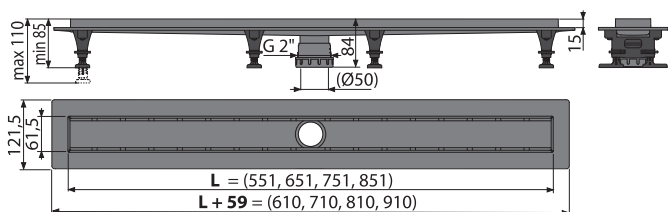

Quantity (packing) APZ2012C-750	12 pcs
Dimensions (piece)	820x143x106 mm
Weight (piece)	1.2318 kg
EAN	8595580562403





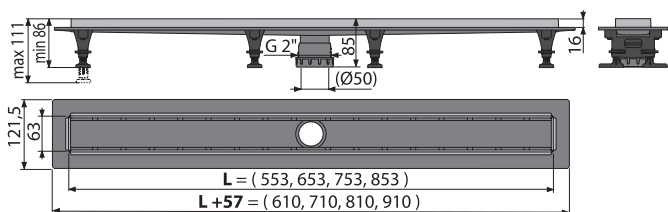







APZ2022C

Shower drain with a stainless steel edge for perforated grids or tile embedding, without odour trap
(550, 650, 750, 850 mm)











Quantity (packing) APZ2022C-750	14 pcs
Dimensions (piece)	820x143x106 mm
Weight (piece)	1.4478 kg
EAN	8595580562441

INDEX

Code	Picture	EAN	Description
A97L		8595580562755	WC flexi connector
A97SN		8595580562366	WC flexi connector
A392C		8595580561543	Wash-basin CLICK/CLACK waste 5/4", metal with overflow, big plug
A504CKM		8595580562540	Bath CLICK/CLACK waste and trap, metal
A504CKM-80		8595580562571	Bath CLICK/CLACK waste and trap, metal
A504CKM-100		8595580562557	Bath CLICK/CLACK waste and trap, metal
A504CKM-120		8595580562564	Bath CLICK/CLACK waste and trap, metal
A507CKM		8595580562533	Bath CLICK/CLACK waste and trap, metal
A507CKM-80		8595580562588	Bath CLICK/CLACK waste and trap, metal
A507CKM-100		8595580562601	Bath CLICK/CLACK waste and trap, metal
A507CKM-120		8595580562595	Bath CLICK/CLACK waste and trap, metal
P155Z		8595580562502	Double connector 17-23 with return valves
P156Z		8595580562519	Double connector 8-23 with return valves

INDEX

Code	Picture	EAN	Description
APZ2012C-550		8595580562380	Shower drain with an edge for perforated grids or tile embedding, without odour trap
APZ2012C-650		8595580562397	Shower drain with an edge for perforated grids or tile embedding, without odour trap
APZ2012C-750		8595580562403	Shower drain with an edge for perforated grids or tile embedding, without odour trap
APZ2012C-850		8595580562410	Shower drain with an edge for perforated grids or tile embedding, without odour trap
APZ2022C-550		8595580562427	Shower drain with a stainless steel edge for perforated grids or tile embedding, without odour trap
APZ2022C-650		8595580562434	Shower drain with a stainless steel edge for perforated grids or tile embedding, without odour trap
APZ2022C-750		8595580562441	Shower drain with a stainless steel edge for perforated grids or tile embedding, without odour trap
APZ2022C-850		8595580562458	Shower drain with a stainless steel edge for perforated grids or tile embedding, without odour trap

The ALCAPLAST team of specialists is always on hand to help with design, installation and quote project prices!

Czech product
ISO 9001:2015



Alca PLAST[®]

CZECH REPUBLIC

Alca plast, s. r. o.
Bratislavská 2846, 690 02 Breclav
tel.: +420 519 821 117 – Sales Dept. CZ
tel.: +420 519 821 041 – Export Dept.
fax: +420 519 821 083
alcaplast@alcaplast.com
www.alcaplast.com